

FRETSAW / SCROLL SAW

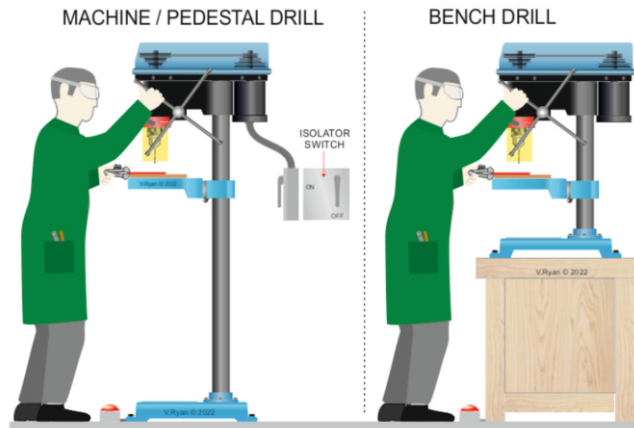

MACHINE DRILLS



HAND DRILLS



RATCHET BRACE

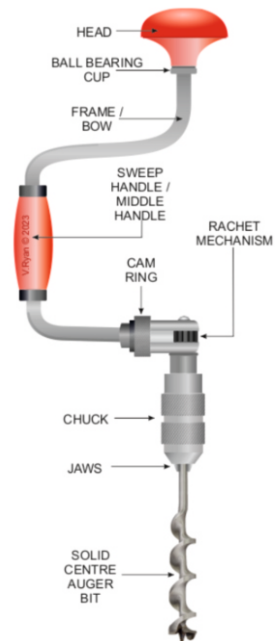

G-CRAMP



BACK SAWS

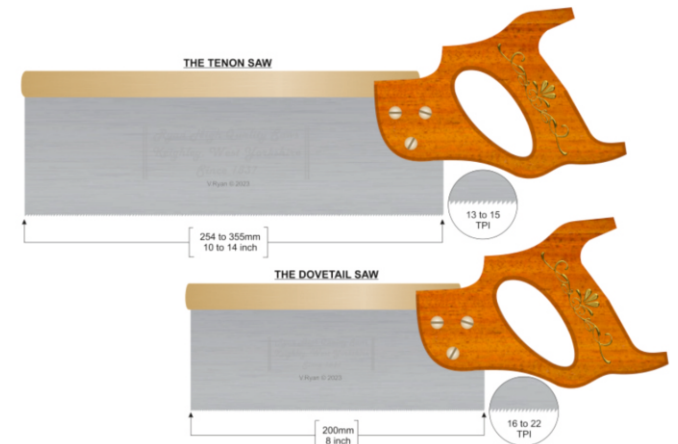

HAND FILES



1

2

3



WOODWORKERS TRY SQUARE



ENGINEERS TRY SQAURE

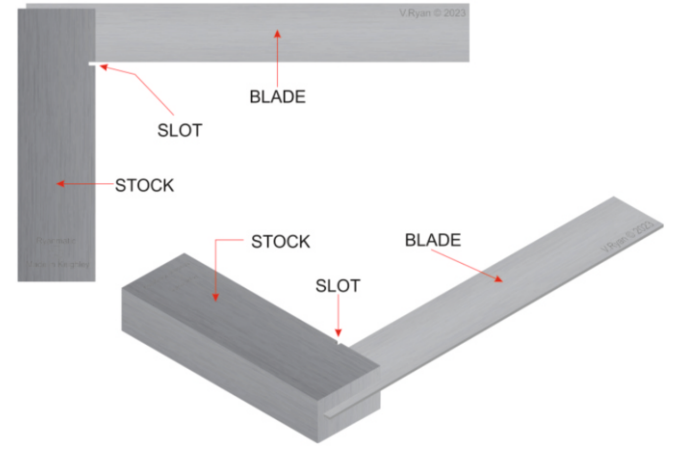

MITRE SQUARE

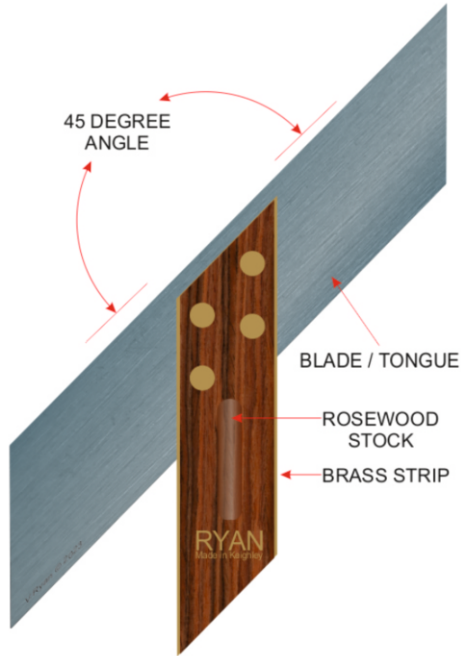

MARKING GAUGE

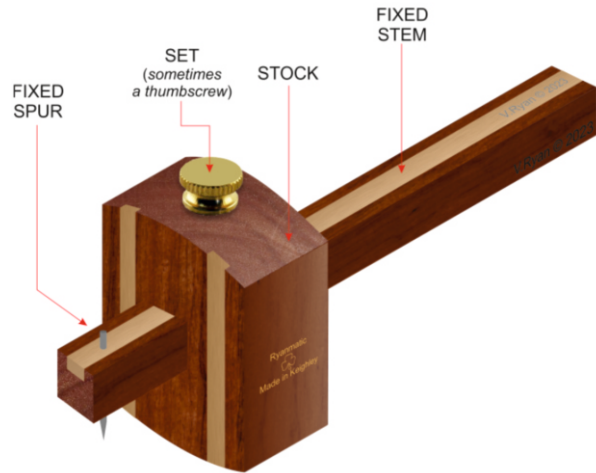

GLUE GUN

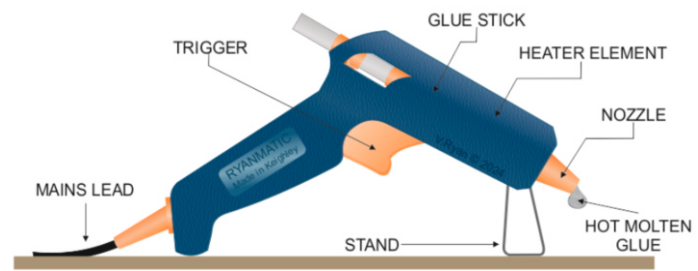

1

2



HACKSAW

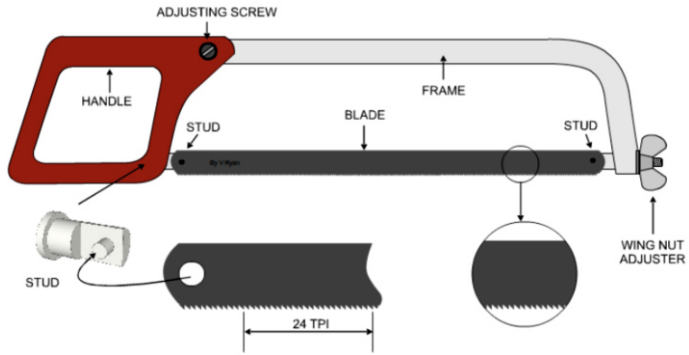

JUNIOR HACKSAW

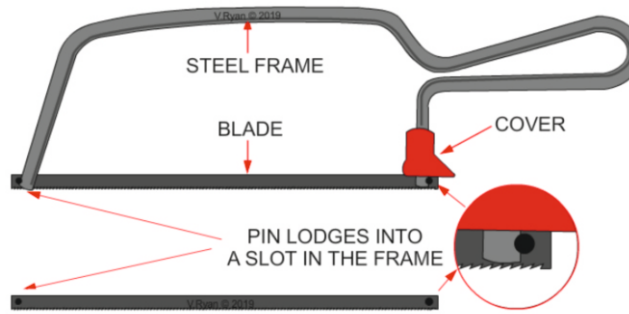

COPING SAW

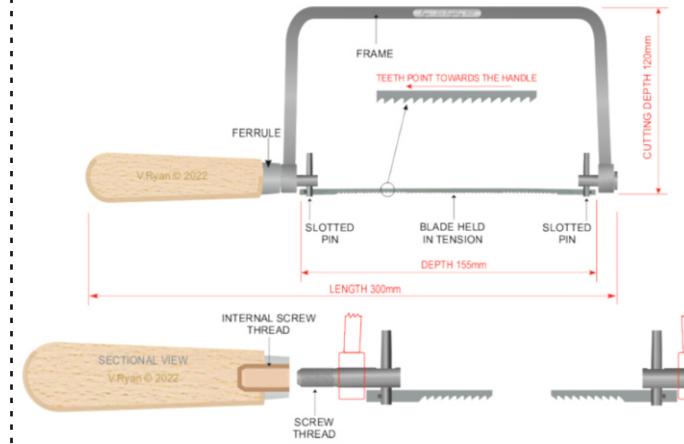

DISK SANDER

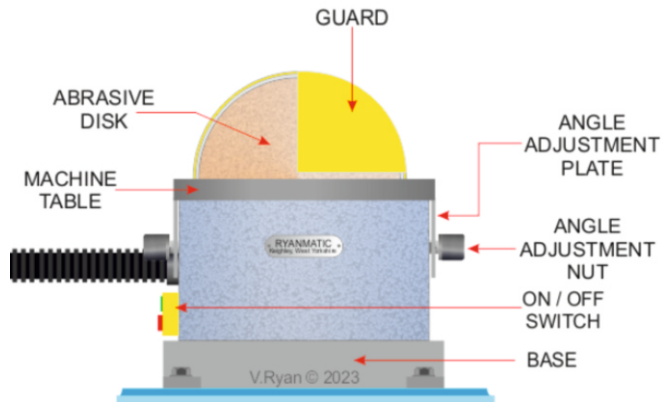

HAND VICE

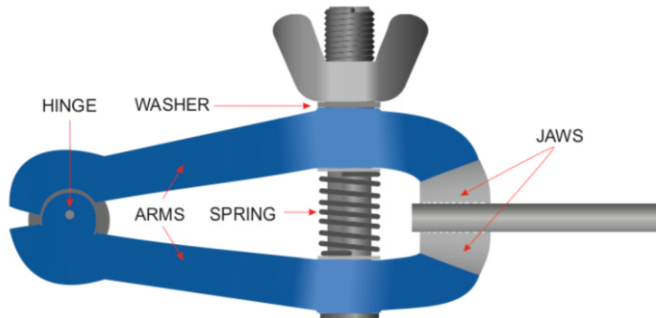

SLIDING BEVEL

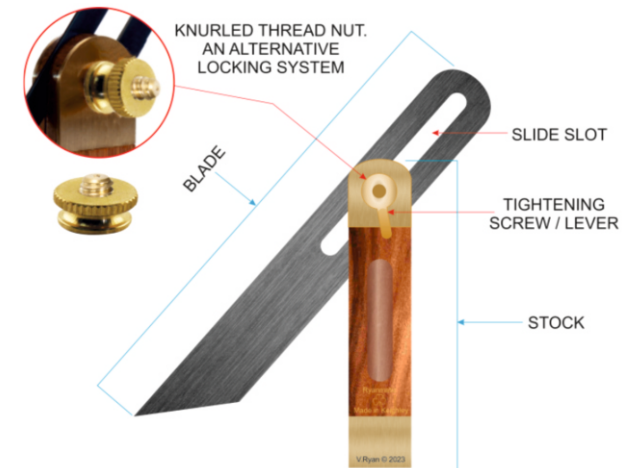

SMOOTHING PLANE + JACK PLANE

SMOOTHING PLANE

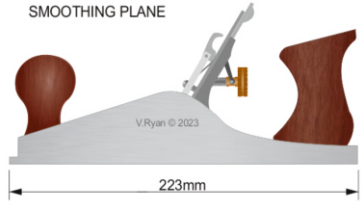

JACK PLANE

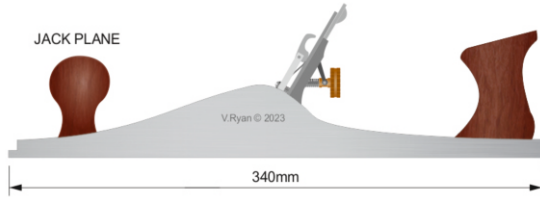

THE SURFORM



BRADAWL

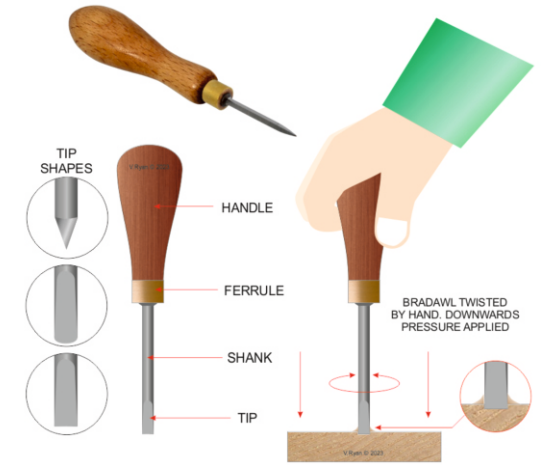

CENTRE PUNCH + DOT PUNCH

TYPICAL CENTRE PUNCH

TYPICAL DOT PUNCH

KNURLED GRIP



KNURLED GRIP

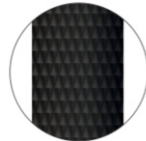

COMMON CHISELS

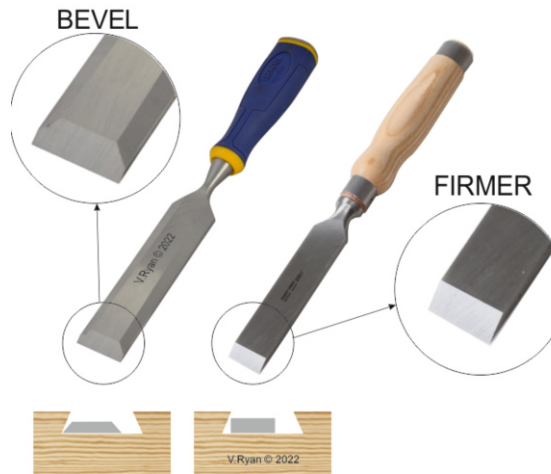

COMBINATION SANDER

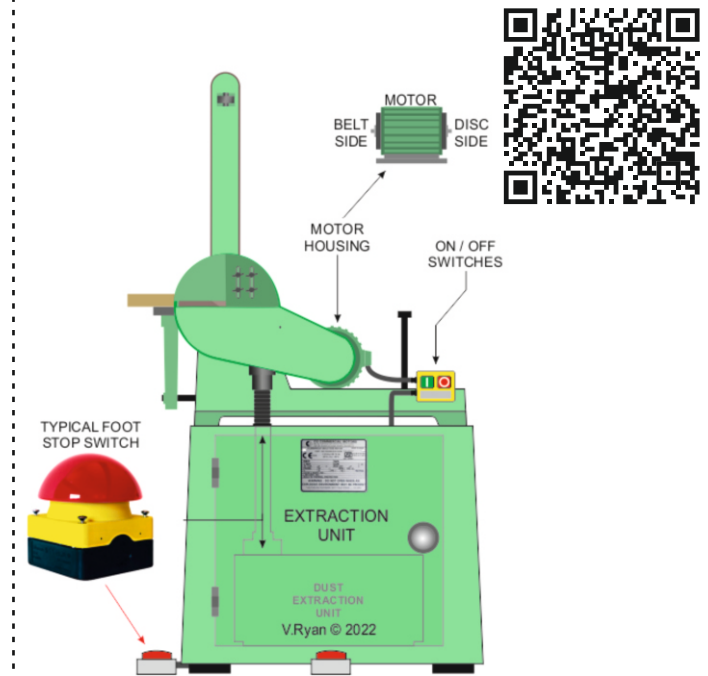

THE PRECISION HAND MITRE SAW

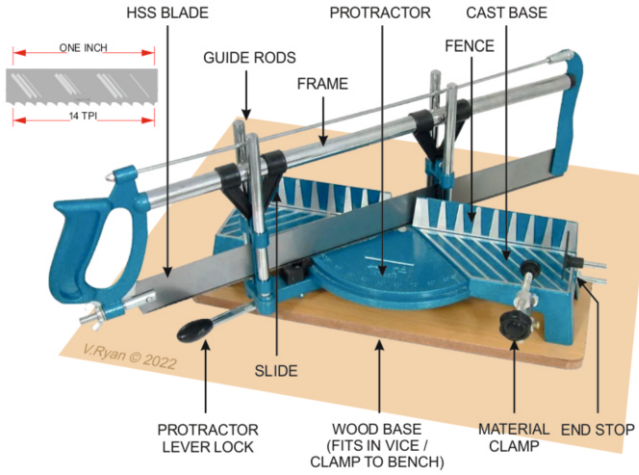

THE POLISHING MACHINE

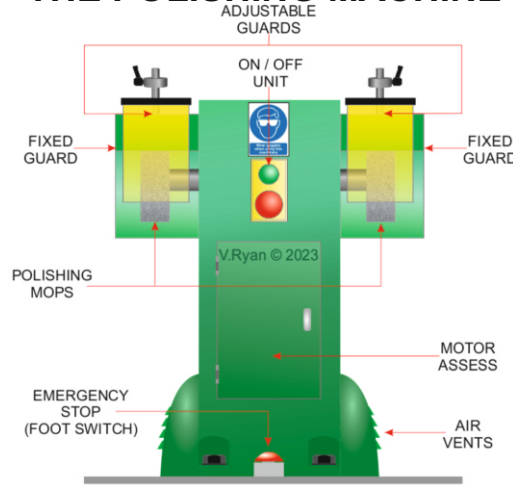

VACUUM FORMING

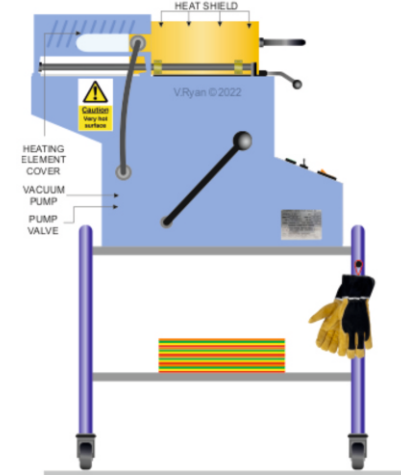

STRIP HEATER



PROFILE CUTTER



BRAZING HEARTH

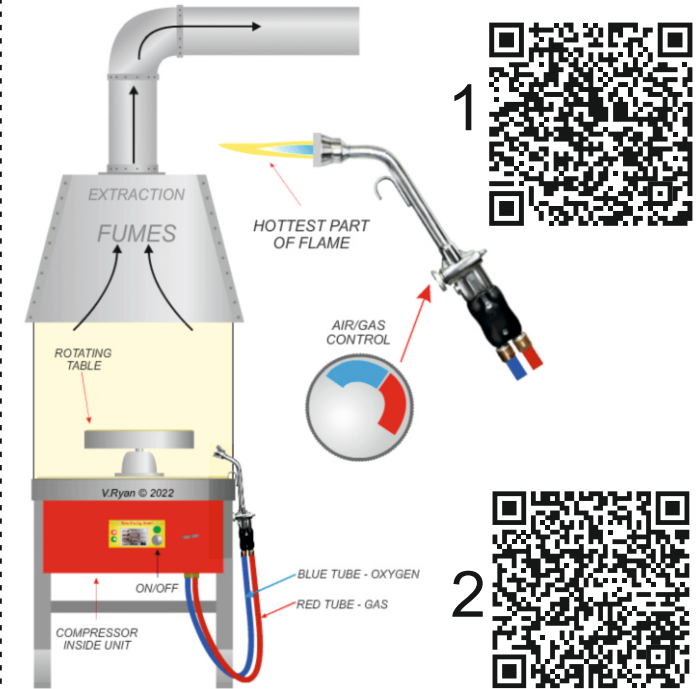

PEWTER CASTING

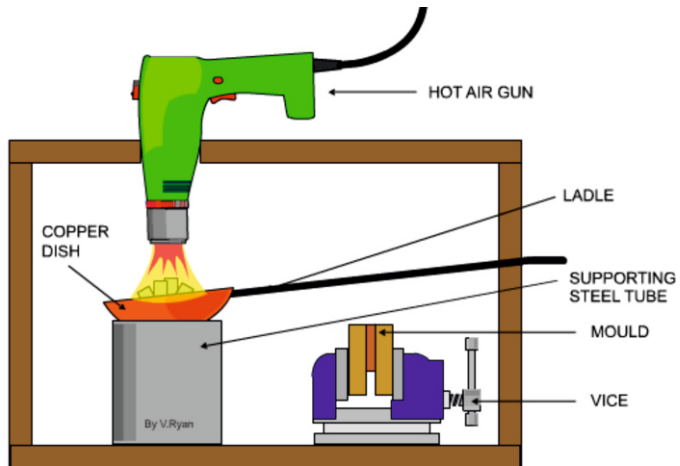

DRAPING / DRAPE FORMING OF PLASTICS



PRESS MOULDING

PRESSURE APPLIED

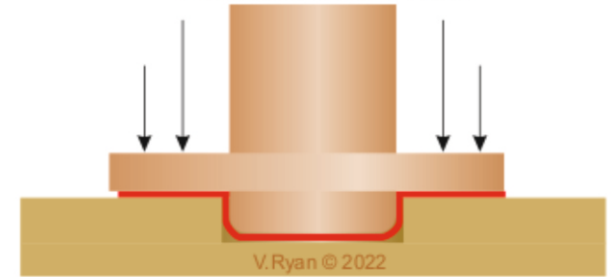

'DISH' SHAPE FORMED



GLUES FOR PLASTICS



THE ART OF DECOUPAGE



ADHESIVES FOR WOODS

